

PARTS LIST

- A.** 1x Type B Main Harness (BB8K002)
- B.** 1x Short Y Splitter Adapters (BB8S001)
- C.** 1x Long Y Splitter Adapters (BB8S002)
- D.** 1x Extension Harness for Perimeter Strobe (BB8SE01)
- E.** 1x Type B Switch Harness
- F.** 1x 5 Core Pigtail
- G.** 6x Connector Caps
- H.** 12x Connector Retainers
- I.** 1x Inline Fuse Holder + 15 Amp Fuse

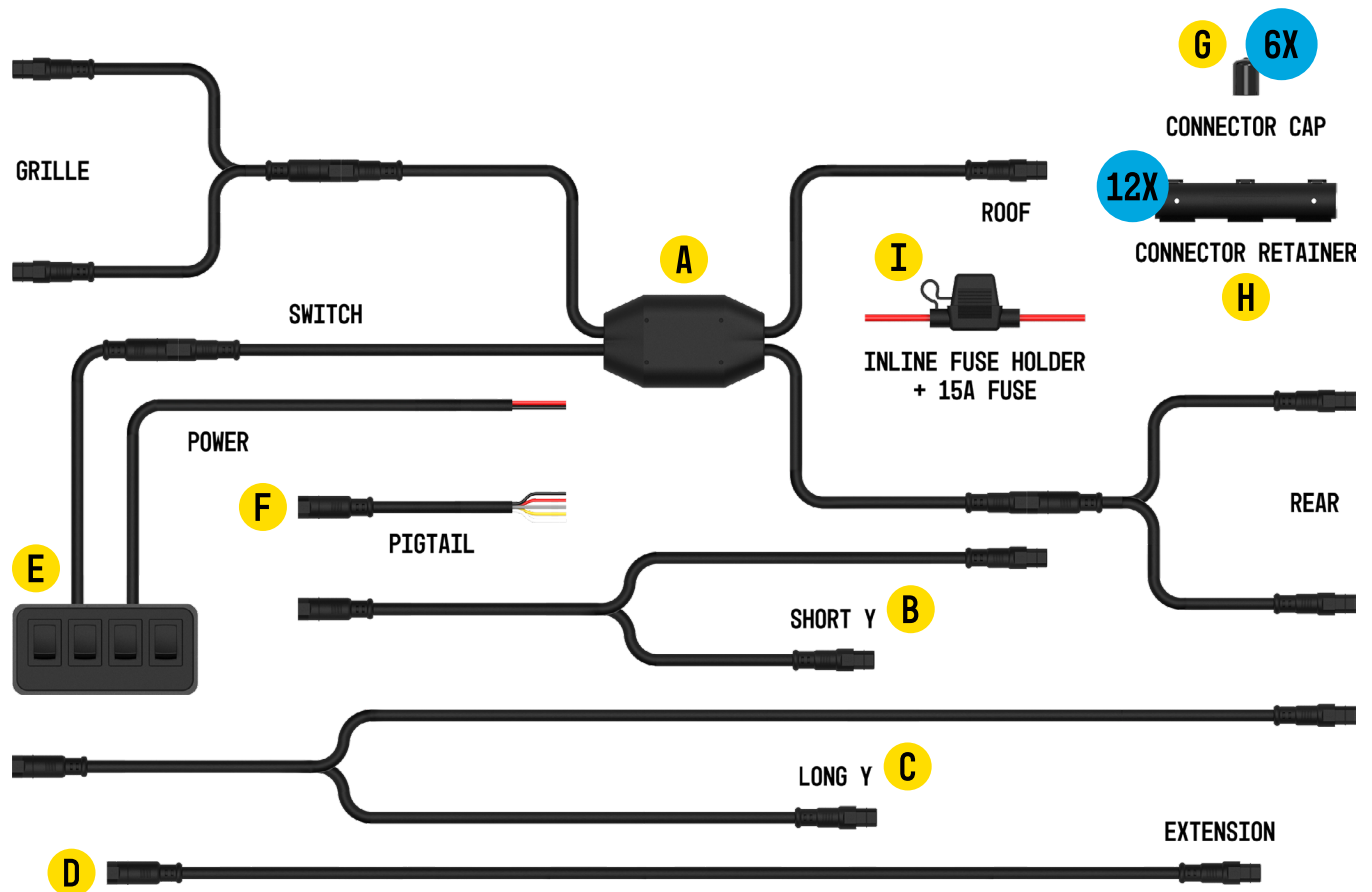



REQUIRED TOOLS

- Zip Ties
- Cable Clips

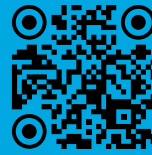

SCAN FOR VIDEO
INSTRUCTIONS OR VISIT
[BUILT-BRIGHT.COM/INSTALL](https://www.built-bright.com/install)



INSTALL NOTES

- No cutting or drilling is required for front grille strobe installation.
- Drilling is only required when mounting the lights on the rear tail gate, bumper or on the body of the truck.
- Approximate installation time is 1.5 - 2 hours (not including bracket installation).
- **Lights are not included in this kit. Compatible lights are listed below.**



COMPATIBLE LIGHTS

SKU	PERIMETER STROBE	COLOR
BB6110A	4" Strobe Light, Amber (1EA)	Amber
BB6110B	4" Strobe Light, Amber/White (1EA)	Amber/White
BB6110C	4" Strobe Light, Amber/Blue (1EA)	Amber/Blue
BB6110D	4" Strobe Light, Amber/Green (1EA)	Amber/Green
BB6010A	4" Strobe Light, Amber (1EA)	Amber
BB6010B	4" Strobe Light, Amber/White (1EA)	Amber/White
BB6010C	4" Strobe Light, Amber/Blue (1EA)	Amber/Blue
BB6010D	4" LED Strobe Light, Amber/Green (1EA)	Amber/Green

DIMENSIONS

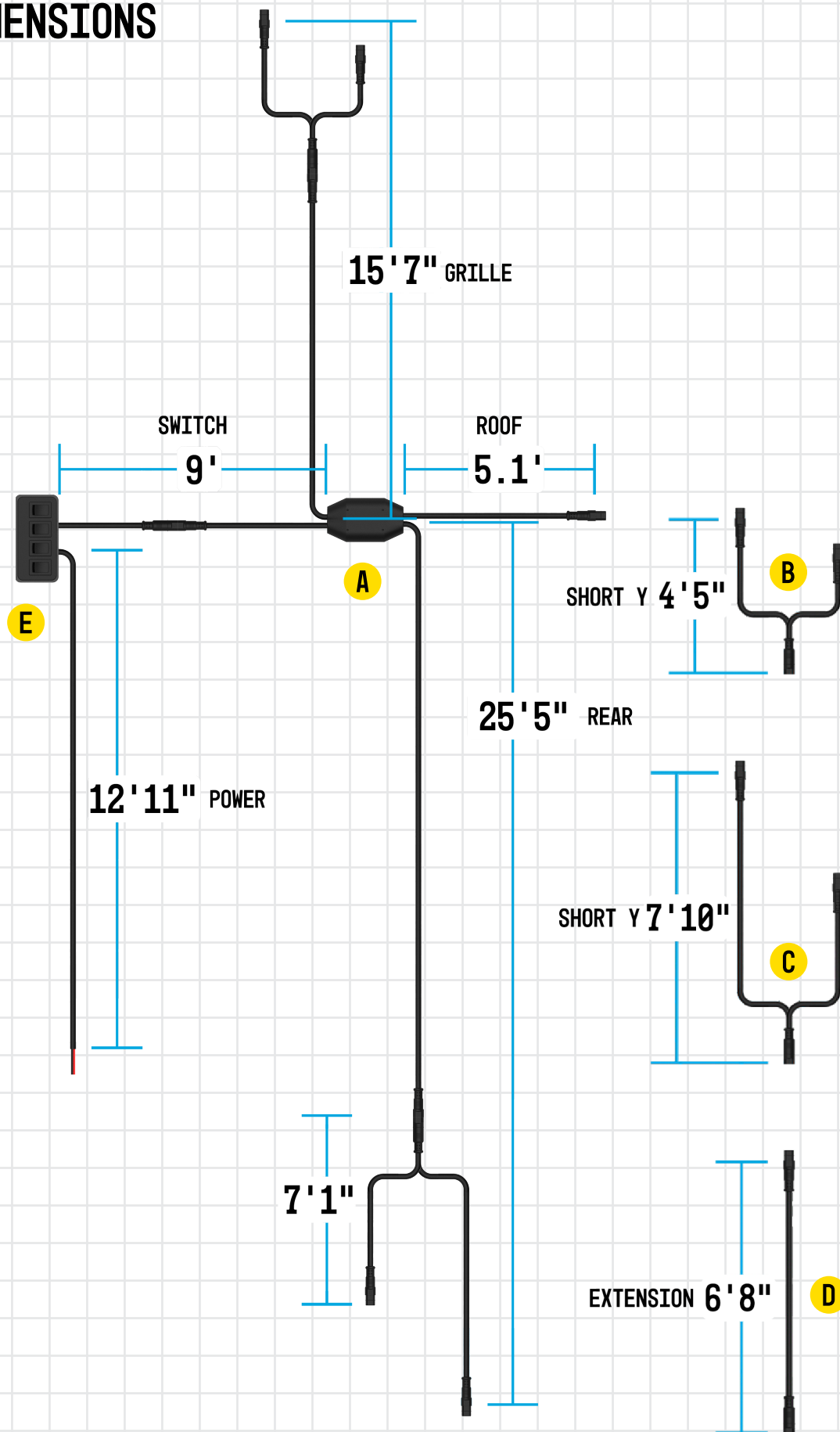



STEP 1 – PLAN THE INSTALL

1. Unbox your harness kit and verify that all parts are present.
 2. Lay out the harness and plan where to install the perimeter strobes (sold separately). Plan and lay out the necessary adapters and extensions alongside the Main Harness (A).
- Note: There are is a Short Y Splitter Adapter (B) and a Long Y Splitter Adapter (C) included in this kit. Please choose the proper adapter according the location you want to install your lights. Examples:
 - The Short Y Splitter Adapter (B) is long enough if you install the front perimeter strobes in the grille. If you want to install the lights on the bumper or side of the vehicle, you may need to use the Long Y Splitter Adapter (C).
 - The Short Y Splitter Adapter (B) is long enough if you install the rear perimeter strobes under the tail gate. If you want to install the lights on the side of the vehicle, you may need to use the Long Y Splitter Adapter (C).
 - The standard harness and splitter adapters are long enough for standard pick up truck beds or flat beds up to 10' long. If you choose to install the rear perimeter strobes on a truck body and route the harness through the cabin, you may need to use the Extension Harness for Perimeter Strobe (D).
 - **An example configuration is shown on the next page for reference.**



EXAMPLE CONFIGURATION

This example uses Harness Kit #BB8KB06, 6x Perimeter Strobe #BB6110B and 2x Grille Bracket Kit #BB96GFA.

Lights and brackets are sold separately.

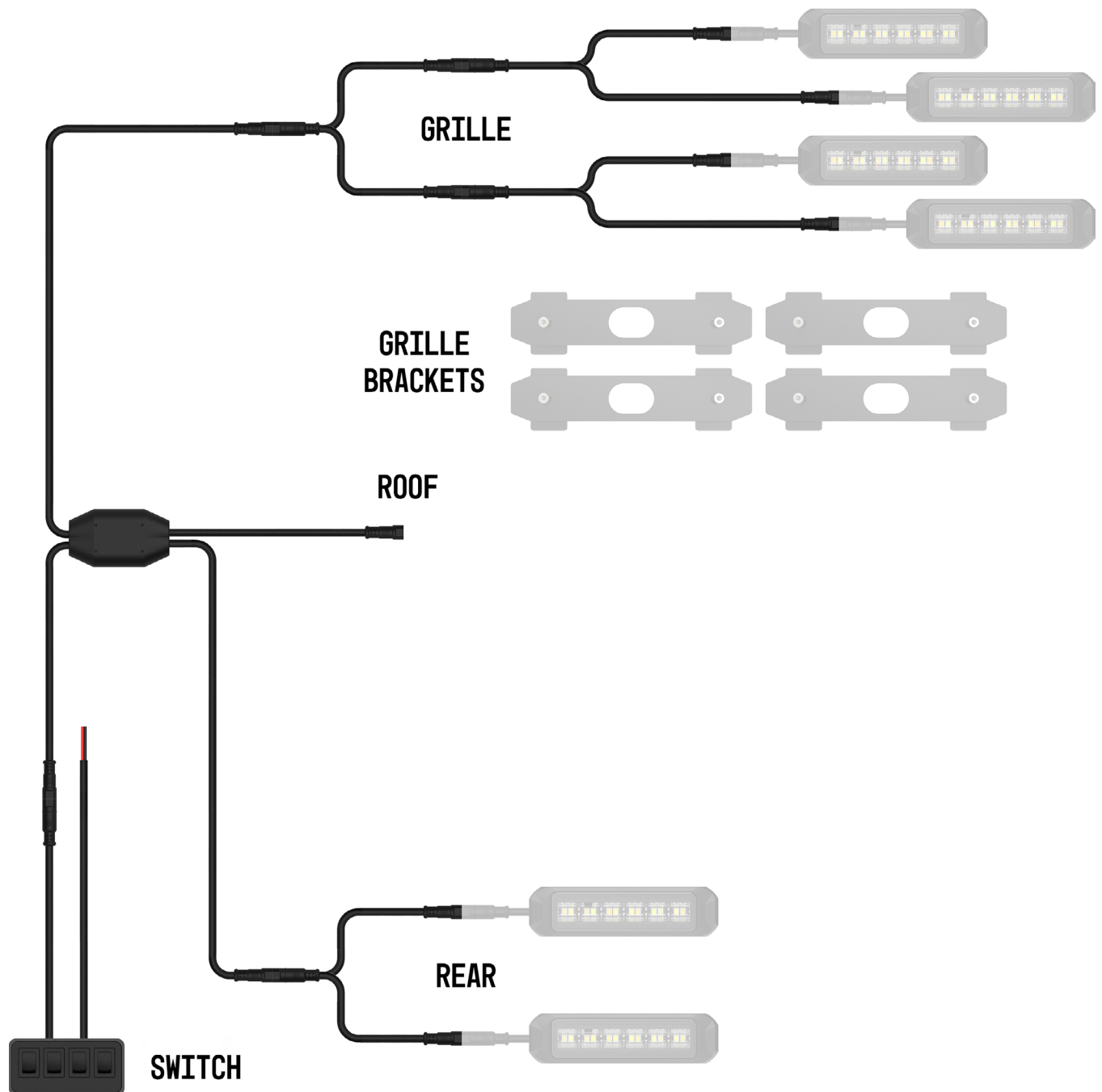



STEP 2 – PROGRAM THE PERIMETER STROBE LIGHTS

We suggest programming the lights and testing harness functionality before beginning installation on the vehicle.

1. Unbox all of the perimeter strobe lights. A waterproof 5 pin male connector and a female pigtail are included in the package of each light.
2. To program grille lights and rear lights in groups (rather than individually), first plug the Switch Harness (E) into the Main Harness (A). Remove the pigtails from all perimeter strobe lights and plug the lights into the Main Harness (A).
3. Using the switch panel, turn on Mode 1. To program the grille lights, toggle the Front Select switch to select the pattern. Press less than 1 second to go to the next pattern and 2 seconds to go back to the previous one. Turn off Front Select, turn on Rear Select (includes both roof and rear lights) and repeat the process. Turn off the Mode 1 switch. Turn on Mode 2 and repeat the pattern selection process. Turn off the Mode 2 switch. Note: You can select different patterns for front or rear on Mode 1 and/or Mode 2.

Refer to the Perimeter Strobe Light manual for the sequence of available flash patterns, or locate your digital manual [here](#).

4. Once complete, disconnect the Perimeter Strobe Lights. You may leave them connected to the Y splitter adapters you've laid out, but leave them unplugged from the Main Harness (A). Disconnect the Switch Harness (E) from the Main Harness (A).

STEP 2 – PROGRAM THE PERIMETER STROBE LIGHTS

3. To program each light individually, use the female pigtail that came with the perimeter strobe light (Fig. 2).



4. See Fig. 3 for individual wire functions. Refer to the perimeter strobe light instructions to program the **RED**, **GREY** and **WHITE** wires to desired strobe patterns.

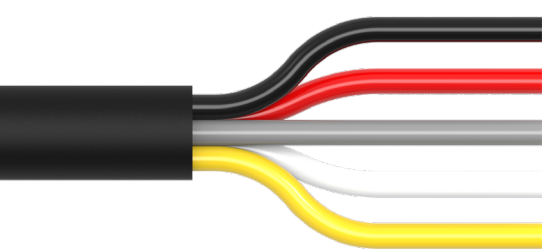

- BLACK** - Ground
- RED** - To +V DC, Programmable Mode 1
- GREY** - To +V DC, Programmable Mode 2
- WHITE** - To +V DC, Programmable Mode 3
- YELLOW** - Pattern Selection

5. Unplug the pigtail(s). If programmed individually, plug the perimeter strobe lights into the Y splitter adapters you've laid out, but leave them unplugged from the Main Harness (A). If programmed together, unplug connections from the Main Harness (A). Light bundles will be reconnected to the Main Harness (A) once it's routed through the vehicle.

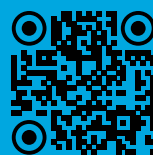

SCAN FOR VIDEO PROGRAMMING
INSTRUCTIONS OR VISIT
BUILT-BRIGHT.COM/PROGRAM

STEP 3 – INSTALL THE HARNESS AND LIGHTS

1. Prior to routing through the vehicle, cap the Main Harness (A) connectors with provided Connector Caps (G). Capping the connectors is highly recommended to prevent dirt or grease getting into the female connectors during installation.





STEP 3 – INSTALL THE HARNESS AND LIGHTS

2. Locate the vehicle's main harness along the frame rail. Route the StrobeLink™ Main Harness (A) alongside it, starting under the cab and working towards the rear.
 3. Remove the Connector Cap (G) and connect the Y splitter adapter for the rear strobe lights.
 4. Route the front portion of the harness under the cab and into the engine bay. Secure to the vehicle's wiring on the firewall or inner fender. **Do not rest the wires against the exhaust.**
 5. Remove the Connector Cap (G) and connect the Y splitter adapter for the front strobe lights.
 6. The top wire of the Main Harness (A) is designed for two perimeter strobes on the roof, top of the headache rack, side of the running board or side of the bed. If used, route the wire labeled "Top" through the vehicle and connect a Y splitter adapter.
- **An example configuration is shown on the next page for reference.**



EXAMPLE CONFIGURATION

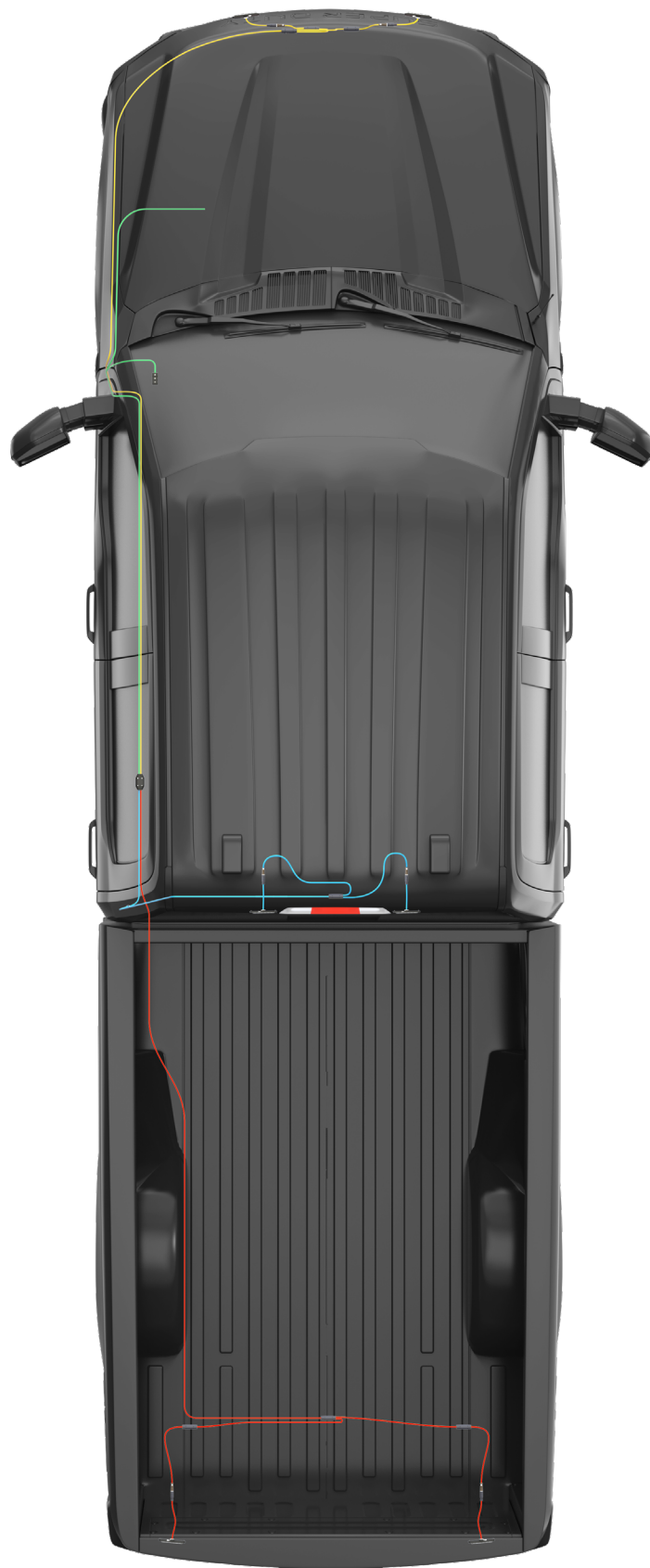



STEP 4 – INSTALL THE LIGHT CONTROL

There are 3 options to control your strobe lights:

1. Use Provided Switch Panel
 2. Use Upfitter Switches
 3. Use 3rd Party Switches
- Note: If the battery or fuse box of the vehicle is on the passenger side , you will need Power Extension Cable BBSE02 (sold separately) to extend between the power connector on the Switch Harness (E) and the pigtail to reach the power source.

Each option is outlined individually on the next 2 pages.

STEP 4 OPTION 1 – USE PROVIDED SWITCH PANEL

1. Connect the Switch Harness (E) to the Main Harness (A). Temporarily connect to a 12V DC power source to test switch functionality. Disconnect the Switch Harness (E) once verified.
2. Enlarge the main harness boot hole on the firewall and route the switch wire of the Main Harness (A) into the cab.
3. Determine the switch panel location and route the Switch Harness (E) switch wire through or under the dashboard and connect it to the Main Harness (A).
4. Route the Switch Harness (E) power wire in the previously cut hole (main harness boot on firewall) and route to the battery.
5. Connect the **BLACK** wire to ground. Connect the **RED** wire to battery power. Add Inline Fuse Holder + 15 Amp Fuse (I).

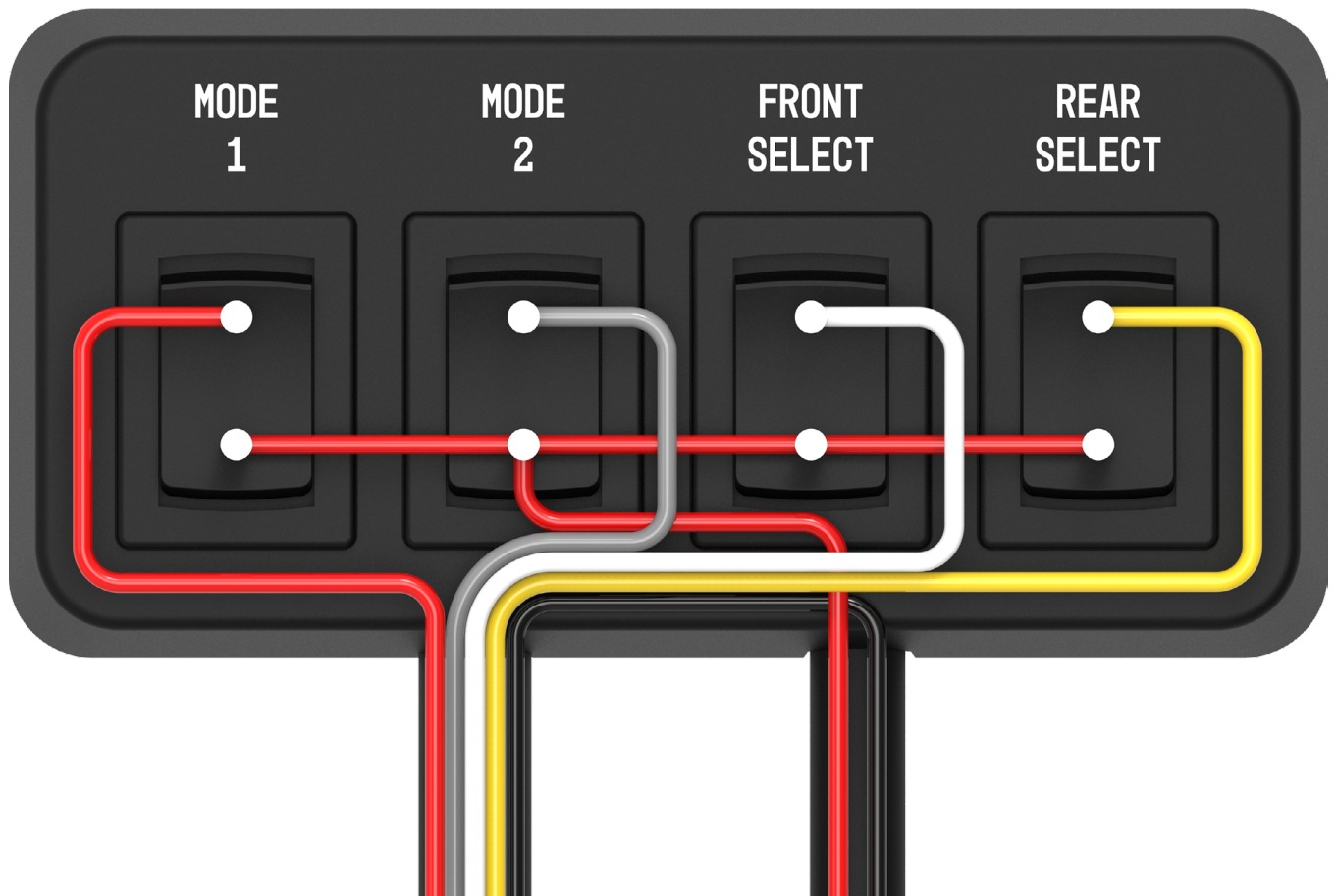

STEP 4 OPTION 2 – USE UPFITTER SWITCHES

1. Plug the provided 5 Core Pigtail (F) into the switch connector on the Main Harness (A). See Fig. 4 for individual wire functions.
2. Locate the upfitter switch relay in the engine bay.
3. Connect the **BLACK** wire to ground.
4. Connect the **RED** or **GREY** wire to the desired upfitter switch relay. When the upfitter switch is activated, that light and pattern will trigger. **WHITE** and **YELLOW** wires are used for pattern change.
5. Unused wires should be separated and protected using heat shrink or tape.

STEP 4 OPTION 3 – USE 3RD PARTY SWITCHES

1. Plug the provided 5 Core Pigtail (F) into the switch connector on the Main Harness (A). See Fig. 4 for individual wire functions.
2. Follow the same wiring instructions from Option 2 above.

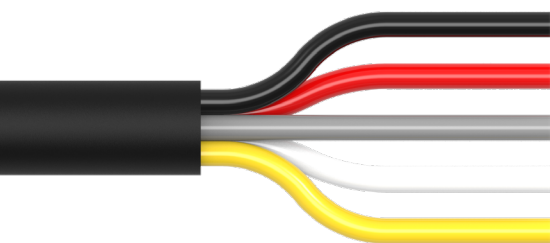
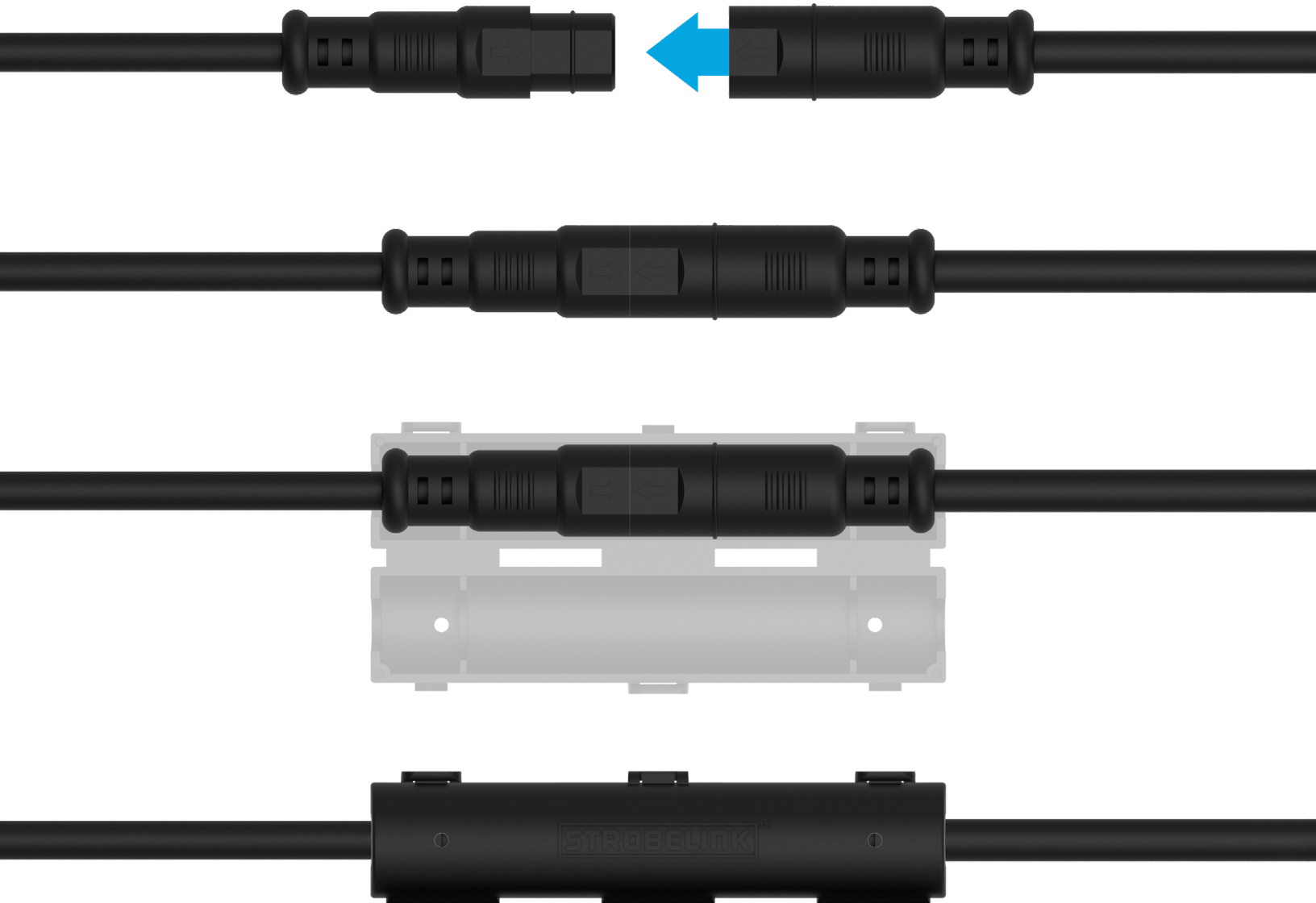

FIG. 4

- BLACK** - Ground
- RED** - To +V DC, Programmable Mode 1
- GREY** - To +V DC, Programmable Mode 2
- WHITE** - Front Pattern Change
- YELLOW** - Rear Pattern Change

STEP 5 – TEST + COMPLETE

1. Test the StrobeLink™ setup for desired functionality. Once verified, secure any wire slack with zip ties.
2. Use the provided Connector Retainers (H) to secure connections. If your vehicle is operated in a high-corrosion environment, apply dielectric grease in the connectors for additional corrosion protection.
3. If there is an unused connector exposed, use a Connector Cap (G) to cap it off. Wrap tape around the cap to secure.



STROBELINK™

ALL-IN-ONE STROBE LIGHT KIT

BUILTBRIGHT

BASTROP, TEXAS 78602
UNITED STATES OF AMERICA
WWW.BUILT-BRIGHT.COM

