

# TINY MONSTER®

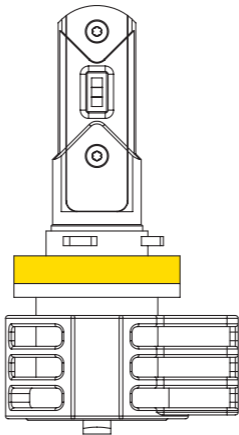

SCAN FOR A  
DIGITAL GUIDE



OWNER'S MANUAL

**CONCEPT BULB**

## NOTES

- Always handle the bulb when it is cool. Avoid touching the base of the LED bulb while it is on, as it can get very hot during operation. Take care to prevent burns or injury.
- Do not apply excessive pressure to the light-emitting part of the bulb. Keep the bulb free from oil, dirt, or any other contaminants that could adhere to the bulb and cause permanent damage.
- Never look directly at the bulb while it is in operation, as it emits extremely high-intensity light that could cause eye damage.

## STEP 1

Access the rear of the factory assembly for the bulb you are replacing. Locate and remove your factory bulb. Refer to the vehicle's installation manual for proper instructions to access the correct bulb.

**Note:** Some housings have rubber or plastic dust caps. Remove the dust cap to access the stock bulb.

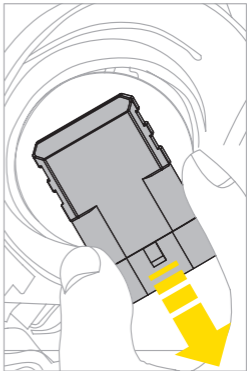

## STEP 2

Install the bulbs into the assembly. For most bulb types, use the same install steps as replacing the stock bulbs.

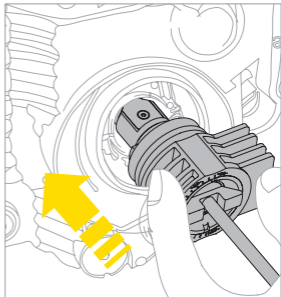

For H3 bulbs, the collar on the LED bulb needs to be removed before installation. First, place the collar into the socket then put the factory metal clip or plastic retainer ring to place. Finally insert the bulb and turn the bulb clockwise to lock.

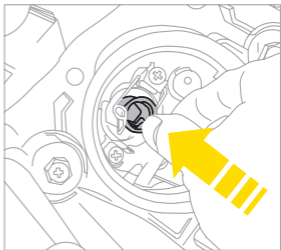
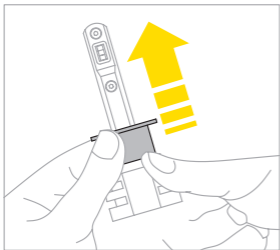

## STEP 3

Check to make sure the position of the diodes (LED chips) are in a horizontal side to side orientation. (See bulb orientation instructions).  
Note: If the bulb is tilted at an angle when installed on your vehicle, correct it by adjusting the bulb head. (See bulb adjustment instructions).

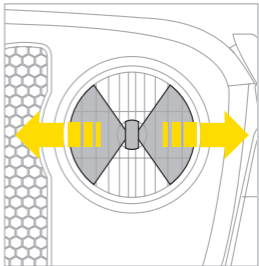

## STEP 4

Insert the connectors of the LED bulb into the factory harness socket.

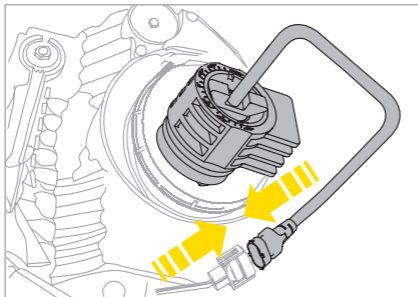

## STEP 5

**OPTIONAL:** If you ordered additional Decoder Harnesses to correct power signals on certain vehicles, plug the Decoder Harness in to the factory socket first, then connect the LED bulb to the Decoder Harness module. (See Decoder Harness instructions for detailed steps).

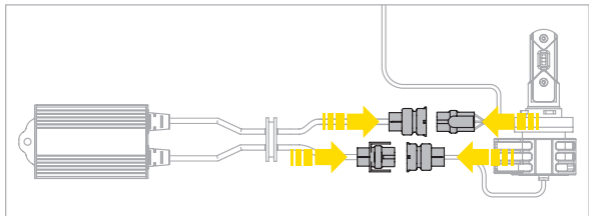

## STEP 6

Route and secure all wiring. If your lamp assembly uses dust caps, the wiring will be affixed outside the dust cap. Then zip tie and/or secure the wire in the engine bay.

**Note:** Replacement rubber or plastic dust caps are readily available and inexpensive.

## STEP 7

As a result of replacing the bulb, the axis of the light may become misaligned. Confirm the alignment of your lamp assembly by following orientation and adjustment instructions later in this manual.

Enjoy your new Tiny Monster LED Performance Bulbs!

# ORIENTATION

Check to make sure the position of the diodes (LED chips) are in a horizontal side-to-side orientation.

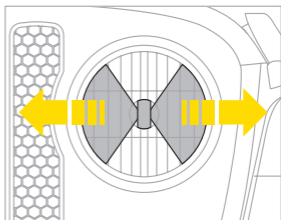
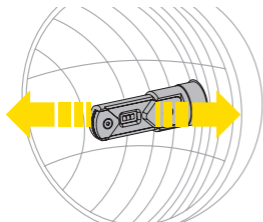

**NOTE:** Dual filament bulbs have two sets of LED chips. Ensure the chip alignment matches the illustration below.

## H13/H4/9004/9007

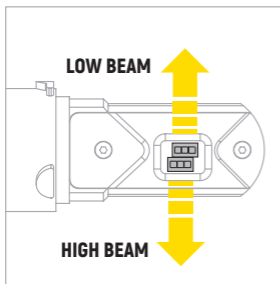

# ADJUSTMENT

Note: H15, H11B, H1, H4, and H7 bulbs do not have rapid aim.

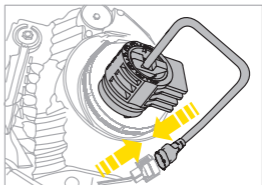
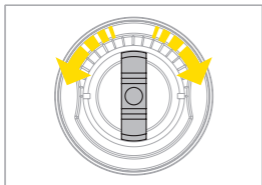
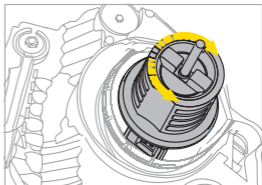
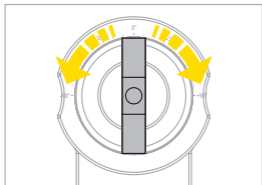

1. Insert the bulb into the original car lamp assembly. Lock the bulb in position.
2. Check the angle of the LED chips to determine the direction and angle adjustment required.
3. To adjust, simply rotate the built-in key at the base of the bulb to the desired position.

## CAUTION:

- Do not forcibly rotate the key. If the key is too tight to turn, remove the bulb from the housing and rotate the key to loosen it before reinstallation.
- Do not handle the bulb when it is turned on.

# TROUBLESHOOTING

## **1. Lights do not turn on:**

If the bulb does not light up, disconnect the electrical connector and reverse it 180°, then reinstall.

## **2. Incorrect beam pattern:**

If the beam pattern does not appear correct, or is skewed, carefully inspect the mounting and position of the bulb in the assembly. In most cases, this is due to misalignment or a problem with rotation. Make sure the bulb is vertically aligned in the socket, and adjust the rotation if necessary.

## **3. Light flickering / lights turn on and off intermittently / bulb out error on dash:**

If you experience flickering while the vehicle is running, or a bulb out error, you may need the decoder harness for your vehicles electrical system. Please contact us if the issue persists after the decoder harnesses are installed.

For more details please visit  
[www.arc.lighting/troubleshooting](http://www.arc.lighting/troubleshooting)



# REGULATIONS FOR USE OF LED BULBS IN HALOGEN HEADLIGHTS

ARC Lighting LED bulbs are tested as street legal in the United States for fog light use only. They are not compliant with DOT / FMVSS108<sup>1</sup> and are therefore not street legal in the USA for use as headlights. ARC Lighting LED bulbs are legal for off road use as headlights on Snowmobiles, ATVs, construction equipment and off road racing and enthusiast vehicles. International street legality will vary by country.

**Please note:** This usage regulation is not unique to ARC Lighting LED bulbs. Regardless of their marketing claims, all LED bulbs from other brands are prohibited from street use in halogen headlights in the United States.<sup>2</sup>

1 - In the United States, lamps, reflective devices and associated equipment are regulated by the US Department of Transportation (DOT) National Highway Traffic Safety Administration's FMVSS108 document. DOT / FMVSS108 applies to all vehicles used on public streets in the United States. DOT regulated products must comply with DOT / FMVSS108 in order to be street legal in the United States. For example, headlights are regulated by DOT / FMVSS108 and must comply with DOT / FMVSS108 to be street legal in the USA. However, fog light bulbs are not regulated by DOT / FMVSS108 and are considered street legal in the USA.

2 - Vehicle lighting bulbs are classified by 'base fitment' type, universally by OEM and aftermarket industry standards. Fitment does not confirm street legality in the USA. Street legality in the USA for retrofitting bulbs varies by both vehicle usage and light type. Bulbs are not available for purchase for illegal street usage. We recognize select vehicles could be used on public streets or off road (not on public streets). Only vehicles which are strictly and 100% exclusively limited to off road use qualify as off road vehicles.

# DOT COMPLIANCE ACKNOWLEDGMENT

Please check your usage on the chart below and confirm that you will not use the bulbs for illegal street usage:

USAGE	DOT / FMVSS1081 REGULATED	STREET LEGAL	SALABLE
<b>FOG LIGHTS</b> Any vehicle	✗	✓	✓
<b>STREET DRIVEN VEHICLE</b> DOT registered with license plates	✓	✗	✗
<b>MIXED USE VEHICLE</b> DOT registered with license plates, driven both on-road and off-road	✓	✗	✗
<b>OFF ROAD VEHICLE</b> Snowmobile, ATV, Off Road Racing or Enthusiast Vehicle, International Vehicle, Construction Equipment	✓	✓	✓



# WARRANTY

## **Terms of this Warranty**

ARC Lighting warranties all Concept products from defects in material and workmanship for (2) two years from the retail date of purchase. This warranty applies only to the original purchaser and is non transferable. Your original sales receipt will serve as proof of purchase for this warranty. Before credit can be issued on a warranty claim, proof of defect may be required. This can be determined at the time of the claim.

## **Exclusions of this Warranty**

Not covered under this warranty is failure due to neglect, improper installation including any modifications, alterations, abuse, accident, weather related damage or by any type of impact.

## **Repair and Replacement**

In the event that your part is found to be defective under the terms of this warranty, it is at the discretion of ARC Lighting to repair or replace the defective part. All repairs must be made under the direction of ARC Lighting. ARC Lighting is not responsible for any removal, installation, reinstallation, or transportation costs associated with the warranted claim.

Please submit any warranty claim at **[www.arc.lighting/warranty](http://www.arc.lighting/warranty)**. It only takes a few minutes to complete and will streamline the process.

# CONCEPT BULB

Thank you for purchasing ARC Lighting products. Please read this instruction manual thoroughly for proper use of the product. After completing your installation, keep this manual for future reference.

For more product information and resources please visit [www.arc.lighting/user-guide](http://www.arc.lighting/user-guide)

## INCLUDES:

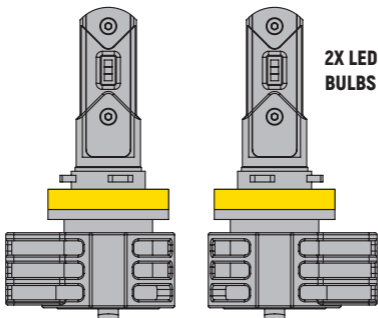

ARC LIGHTING  
(888) 608-2220 | [WWW.ARC.LIGHTING](http://WWW.ARC.LIGHTING)

